



Labond Stair Nosings Series A980

Pre-fabricated stair nosings System

預制式防滑級咀系統

MODEL A980-SN-1: Stainless steel nosings

- with nonslip epoxy mixed carborandum strip
- counter sunked S.S. Screw @300c/c
- Hair line finishing
- Dimension 80mm X 15mm

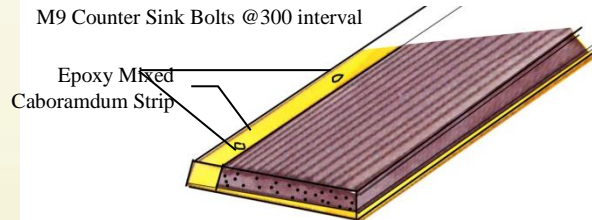
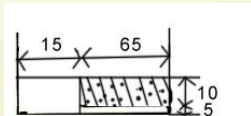

Typical Detail of MODEL "SN-1"

MODEL A980SN-2: Natural, Gold or Bronze Anodised Aluminium Stair Nosings

- Drilled profiles.
- Standard lengths of 340 cm
- Dimensions: l 35mm X h 26mm
- For 3-mm-thick finishings: carpet, vinyl, tile.

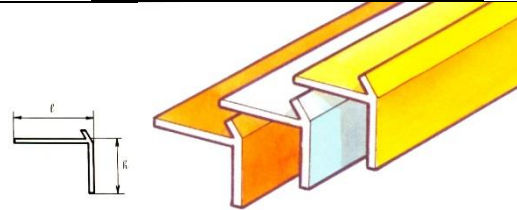

MODEL A980-SN-3: Extruded Anodised Aluminium Stair Nosings

- With nonslip adhesive carborandum.
- Drilled for plug and screw attachment.
- Natural, gold or bronze anodising.
- Also available with adhesive layer.
- Dimensions: l 52mm X h 30mm
- Standard lengths of 340 cm.
- Lengths of 113cm and 166cm can be supplied upon request.
- Carborandum strip available in rolls of 18.20 meters x 19 mm: black or brown colour.

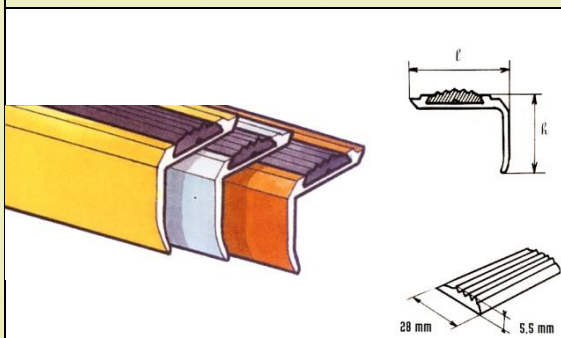
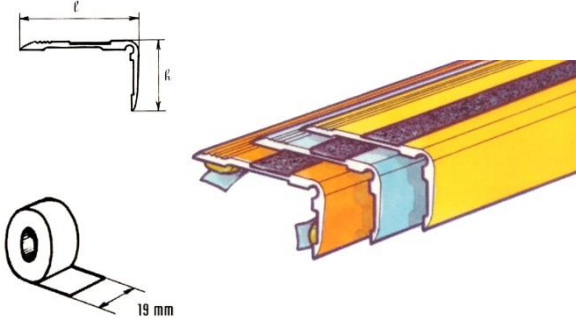

MODEL A980-SN-4: Extruded Anodised Aluminium Stair Nosings

- Drilled profiles, nonslip flexible PVC insert.
- Natural, gold or bronze anodizing.
- Plug and screw attachment.
- Dimensions: l 42mm X h 18mm
l 42mm X h 33mm
- Standard lengths of 340 cm. Lengths of 113 cm and 166 cm can be supplied upon request.
- Nonslip flexible PVC insert supplied in 34-meter rolls: black colour.

MODEL A980-SN-5: Extruded Anodised Aluminium Stair Nosings

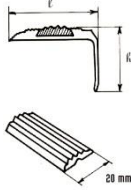
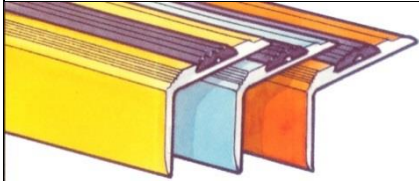

- Drilled profiles, nonslip flexible PVC insert.
- Natural, gold or bronze anodizing.
- Plug and screw attachment.
- Dimensions: 146mm X h 30mm
- Standard lengths of 340 cm. Lengths of 113 cm and 166 cm can be supplied upon request.
- Nonslip flexible PVC insert supplied in 34-meter rolls: black colour.

MODEL A980-SN-6: Extruded Anodised Aluminium Stair Nosings

- Drilled profiles, nonslip flexible PVC insert.
- Natural, gold or bronze anodizing.
- Plug and screw attachment.
- Dimensions: 148mm X h 40mm
- Standard lengths of 340 cm. Lengths of 113 cm and 166 cm can be supplied upon request.
- Nonslip flexible PVC insert supplied in 34-meter rolls: black colour.

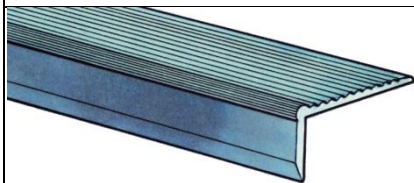
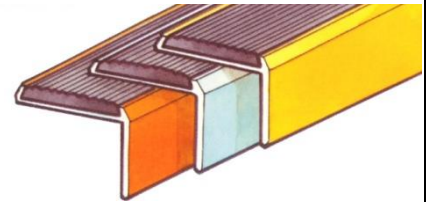
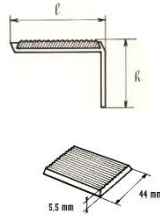

MODEL A980-SN-7: Nonslip Extruded Anodised Aluminium Stair Nosings

- Dimensions: 40 x 20 x 3 mm.
- Standard lengths of 3 meters.
- Adhesive or plug and screw attachment [screw ø3.5mm; plug ø 5mm].

MODEL A980-SN-8: Nonslip Extruded Aluminium Stair Nosings

- Natural, gold or bronze anodizing.
- Dimensions: 120mm X h 20mm
- 124.5mm X h 10mm
- 142mm X h 15mm
- 124.5mm X h 20mm
- Drilled profiles in standard lengths of 340 cm. Lengths of 113 cm and 166 cm can be supplied upon request.
- Also available with adhesive layer.

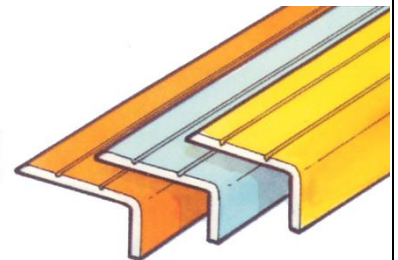
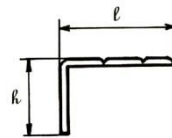

MODEL A980-SN-9: Nonslip Extruded Aluminium Stair Nosings

- Dimensions: 120mm X h 20mm
- 130mm X h 30mm
- Drilled profiles in standard lengths of 270 cm. Lengths of 90 cm and 135 cm can be supplied upon request.
- Also available with adhesive layer.

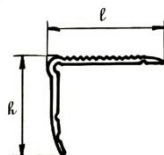
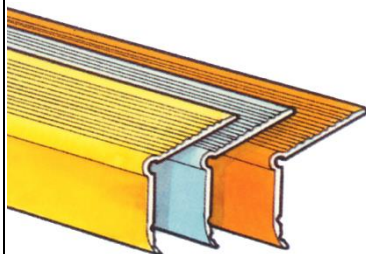
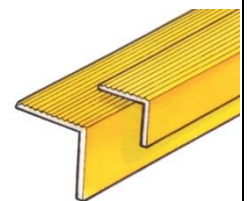
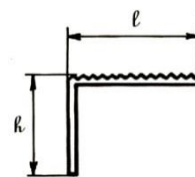

MODEL A980-SN-10: Nonslip Extruded Aluminium Stair Nosings

- Natural, gold or bronze anodizing, bronze anodized upon request.
- Drilled profiles in standard lengths of 340 cm.
- Dimensions: 154mm X h 47mm